

Project

Better Energy^{Inc.}



FoxESS Smart WIFI V2.0
User Manual

WiFi Stick Installation

Step 1: Plug the Smart WiFi 2.0 into the WiFi/GPRS port on the (underside) of the inverter.

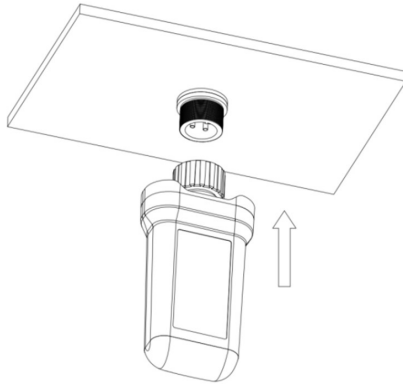

Step 2: Tighten the nut clockwise (as shown in the below).

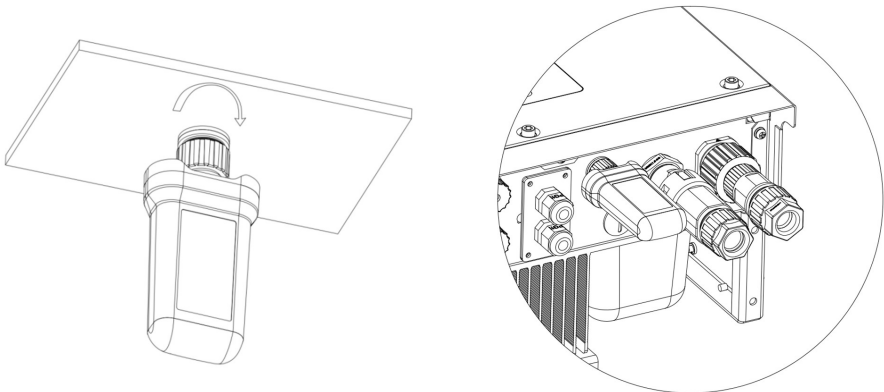

Step 3: Power on the inverter (in accordance with the start-up procedure detailed in the inverter user manual).

App Installation

Scan the QR Code below to download and install the FoxCloud App on your smart phone. Alternatively, search for the FoxCloud App in the App Store or Google Play Store.



HUAWEI AppGallery



Google Play



Apple App Store

Configuration

















Step 1

Connect your mobile device with Smart WiFi.

The SSID of the Smart WiFi is '**W-xxxxx**' and the password is '**mtmt2020**'.

CONNECTED

-  **W-9123456**
Connected, no internet  
-  **FOX-A6VA020**
Can't connect to the internet  
-  **FOX-ESS-LabTest**
Saved  
-  **FOX-A6VA004**
Saved  
-  **FOX-ESS-PC** 2.4G/5G
Can't connect to the internet  

Step 2

Once you have connected successfully, open any internet browser and enter '**192.168.1.1**' into the address bar on Top.

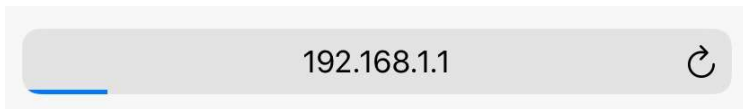

Step 3

Scroll down in the WiFi SSID menu to find house router and input the house router's password. Click 'Save'.

Set-up net

IP 192.168.10.148

Mac ec:fa:bc:3f:53:fb

WiFi SSID FOX-A6VA020

Password Composed of letters,numbers or und

Save Refresh Clear

Local upgrade

SN 009W2D41A6VA009

Software version 0.6

Hardware version 2.0

Select File Please! Only bin files can be uploaded













Upgrade Clear

**Step 1**

Connect your PC or Laptop with Smart WiFi.

The SSID of the Smart WiFi is **W-xxxxx** and the password is **mtmt2020**.

CONNECTED

-  **W-9123456**
Connected, no internet  
-  **FOX-A6VA020**
Can't connect to the internet  
-  **FOX-ESS-LabTest**
Saved  
-  **FOX-A6VA004**
Saved  

Step 2

After connecting successfully, open any internet browser and enter '192.168.1.1' on the address bar on top.

The screenshot shows a web browser address bar with '192.168.1.1' entered. The page content is divided into two main sections: 'Set-up net' and 'Local upgrade'. The 'Set-up net' section contains fields for IP (192.168.10.148), Mac (ec:fa:bc:3f:53:b), Wifi SSID (W-051B004), and Password (Composed of letters, numbers or underscores). Below these fields are 'Save', 'Refresh', and 'Clear' buttons. The 'Local upgrade' section contains fields for SN (009WZD41AEVA009), Software version (0.6), and Hardware version (2.0). It also features a 'Select File' button with a file selection icon and a note 'Only .bin files can be uploaded'. Below the file selection area are 'Upgrade' and 'Clear' buttons.

Step 3

Scroll down in the WiFi SSID menu to find house router and input the house router's password. Click 'Save'.

This screenshot is identical to the one in Step 2, showing the 'Set-up net' and 'Local upgrade' sections of the 192.168.1.1 web interface. The fields and buttons are the same as described in the previous step.

Registering as an Installer Account



Step 1:

Please click 'Register', enter installer's information and click 'Register' to complete the installer account registration.

Note: * If you already have an installer/agent account, please press login and enter your installer/agent account details.

*** If you are an end user, please contact your installer directly for following steps.**



Step 2:

Select your installer and enter the invitation code, and click 'Join'.

Note: * Installer: the installation company
Agent: the agent/distributor company, installation company purchase from

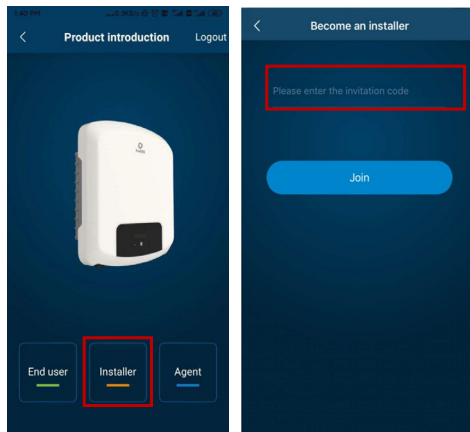

Step 1:

Open any internet browser and enter 'www.foxesscloud.com' into the address bar on the top of the screen. Click '**sign up**'.

Note: * If you already have an installer/agent account, please press 'Sign in' and enter your installer/agent account details.

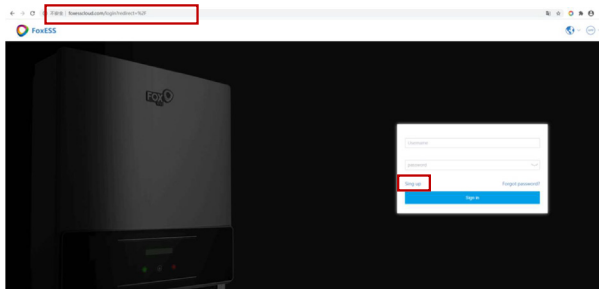

Step 2:

Enter information and click 'Sign up' to complete account registration.

Note: * If you are an end user, please contact your installer for the following steps.

Step 3:

Please select installer and enter the invitation code, and click 'Register'.

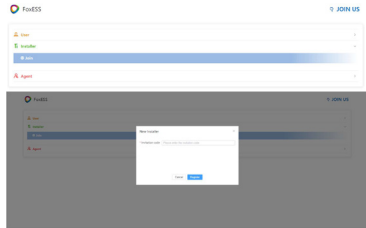
**Create a plant****Step 1:**

Open the App, and login with your installer/agent account.

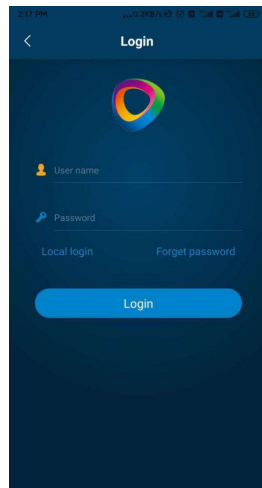

Step 2:

Select end user, scan the WiFi bar code on the smart WiFi device, and click 'OK'.

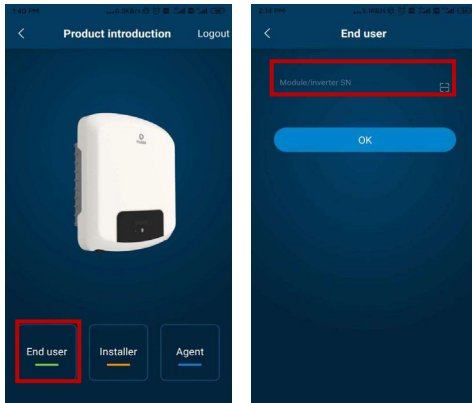

Step 1:

Select end user, input the Serial Number, and click 'Register'.

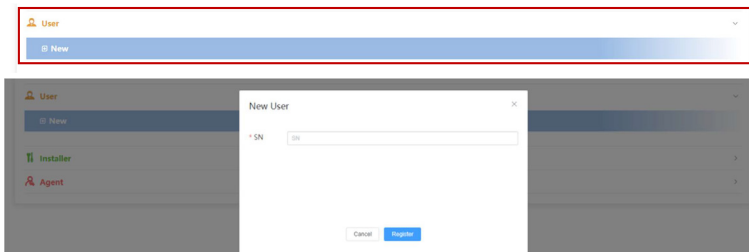

Step 2:

Press the '+' icon on the homepage to add plant. Press the scan icon next to the 'Device' list to scan the QR code label on the side of the Smart WiFi. Some basic information for this plant will populate automatically. Complete all required information and click 'OK' on the top right corner of the page.

Note: After starting the App, a pop-up will show with a message saying 'whether to allow positioning permissions'. Please select 'Allow'. For the capacity, please fill in the actual capacity of the installation of solar panels.

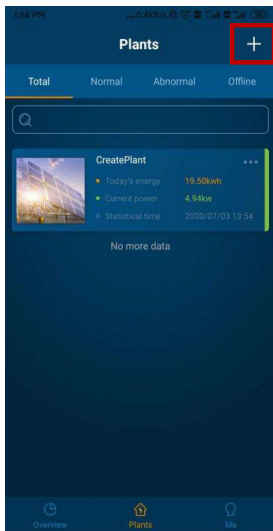



Press the **'New'** button on the homepage to add plant. Fill in all the required information and click **'Create'**.

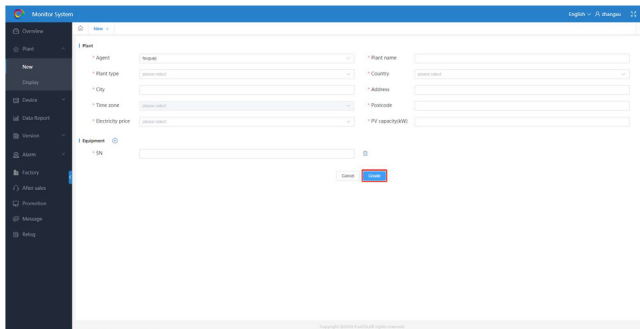

The screenshot shows a web browser window titled 'Monitor System'. On the left is a dark sidebar with a menu containing: Overview, Plant, New, Capacity, Device, Data Import, News, Alarm, Factory, After sales, Forecast, Message, and Help. The main content area is titled 'New' and contains a form with the following fields:

- Plant**
 - *Agent: [dropdown menu]
 - *Plant type: [dropdown menu]
 - *City: [dropdown menu]
 - *Date zone: [dropdown menu]
 - *Electricity price: [dropdown menu]
- Plant name**: [text input]
- *Country**: [dropdown menu]
- *Address**: [text input]
- *Passcode**: [text input]
- *PV capacity(MW)**: [text input]

At the bottom of the form, there is a section for **Equipment** with a sub-section for **SN** containing a text input field. Below the form are 'Cancel' and 'Create' buttons.

End user account registration and sign up



Step 1:
Click **'Register'**, enter end user's information and click **'Register'** again to complete the end user account registration.

